

KENNEDY TOWNSHIP

Allegheny County, Pennsylvania

STREET OPENING PERMIT APPLICATION

HOURS OF NON-EMERGENCY OPERATION: Excavation, construction and maintenance operations of any kind are permitted only during the daytime hours from 7AM to 7PM, Monday thru Friday; 8AM to 7PM on Saturdays, between March 15 and October 31st. Said operations of any kind permitted only from Dawn to Dusk, not before 7AM and not after 5:30pm between November 1st and March 14th. No operations permitted on Sundays and Holidays. NOTIFY POLICE DEPARTMENT OF EMERGENCY OPERATIONS – 412-331-2408 or 911

Applicant Name: _____ **Address:** _____

Day Time Phone _____ **Estimated Starting Date** _____

FAX _____ **Email** _____

Contact _____

Estimated Completion Date: _____

Emergency Contact: _____ **Phone:** _____

Name of Streets to be opened: _____

Nearest Intersection to Street Opening: _____

Street Numbers of Abutting Properties: _____

Size of Opening: _____

Purpose of Opening _____

Job /PA One-Call No. _____

Permit Fee _____ based upon the enclosed fee schedule. **Attention Controller: Make check payable to Township of Kennedy – mailing address: 340 Forest Grove Road, Coraopolis PA 15108.**

ISSUANCE OF THIS STREET OPENING PERMIT IS IMPLIED CONSENT THAT THE APPLICANT HAS SIGNED THE APPLICATION FOR STREET OPENING AND IS BOUND BY THE PROVISIONS OF THE ORDINANCES, SPECIFICATIONS AND REGULATIONS OF THE TOWNSHIP GOVERNING STREET OPENINGS IN OR UNDER TOWNSHIP STREETS AND TO SUCH SPECIAL CONDITIONS, RESTRICTIONS AND REGULATIONS AS MAY BE IMPOSED BY THE MANAGER OR HIS DESIGNEE. FOR OPENINGS MORE THAN 1000 SQUARE FEET, CONTACT TOWNSHIP MANAGER, 412-771-6680, ONE WEEK PRIOR TO CONSTRUCTION TO SCHEDULE A PRE-CONSTRUCTION MEETING WITH THE CONTRACTOR.

APPROVED BY: Gerald G. Orsini
TOWNSHIP TITLE: Township Manager

FEE PAID CK# _____
Permit No: _____

APPROVAL DATE _____

THE ATTACHED STREET RESTORATION SPECS MUST BE OBSERVED WHEN CLOSING A TOWNSHIP STREET. Township inspector Emory Kunkle will confirm the restoration. PLEASE PROVIDE EMERGENCY CONTACT INFORMATION ABOVE

FOR TOWNSHIP USE

FINAL INSPECTION DATE: _____

BY: _____

APPROVED RESTORATION ___ YES ___ NO

Emory Kunkle, Remington Vernick & Beach Engineers

Cc: Kennedy Township Road Department

**TOWNSHIP OF KENNEDY
ALLEGHENY COUNTY, PENNSYLVANIA
ORDINANCE NO. 427**

AN ORDINANCE OF THE TOWNSHIP OF KENNEDY, ALLEGHENY COUNTY, PENNSYLVANIA, AMENDING SECTION 5 OF ORDINANCE NO. 321, REGULATING THE GROUND OPENING OF STREETS AND RIGHT-OF-WAYS FOR THE USE OF THE PUBLIC.

WHEREAS, the Kennedy Township Board of Commissioners find it necessary to adjust certain permit fees within the Township to maintain a fiscal balance to the administration of certain fees.

NOW AND THEREFORE BE IT ORDAINED AND ENACTED by the Board of Commissioners of the Township of Kennedy, Allegheny County, Pennsylvania, and it is hereby ordained and enacted by the authority of the same as follows:

SECTION 1: Section 5 of Ordinance No. 321 is amended to read as follows:

Each and every applicant shall pay to the Township the following permit fees at the time application is made for a permit to excavate or open any street or right-of-way in the Township. Where the excavation or opening is:

- a. Less than 100 sq. ft. \$ 150.00
- b. 100 sq. ft. but less than 200 sq. ft. \$ 225.00
- c. 200 sq. ft. but less than 300 sq. ft. \$ 300.00
- d. 300 sq. ft. but less than 1,000 sq. ft. \$ 650.00
- e. Each additional 300 sq. ft. or part thereof will be an additional \$ 300.00

SECTION 2: All other Ordinances and Resolutions and/or parts of Ordinances or Resolutions conflicting with this Ordinance are hereby repealed.

SECTION 3: This Ordinance shall become effective and enacted the first day of January in the year 2006.

ORDAINED AND ENACTED by the Board of Commissioners of the Township of Kennedy this 12th day of December 2005.

ATTEST:

TOWNSHIP OF KENNEDY

Gary R. Vituccio
Township Manager



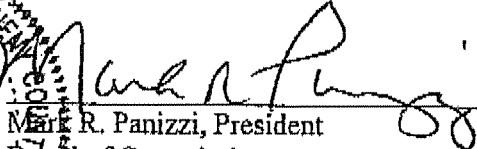

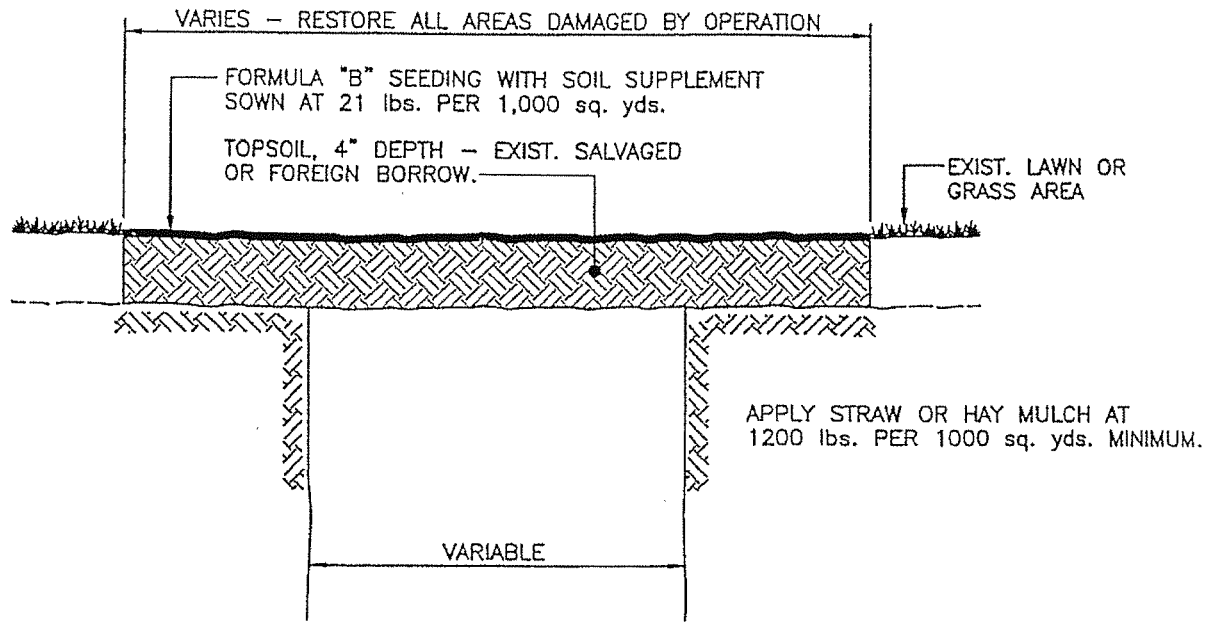
Mark R. Panizzi, President
Board of Commissioners



LAWN AND GRASS AREA
RESTORATION DETAIL

EXISTING
SLAG DRIVEWAY

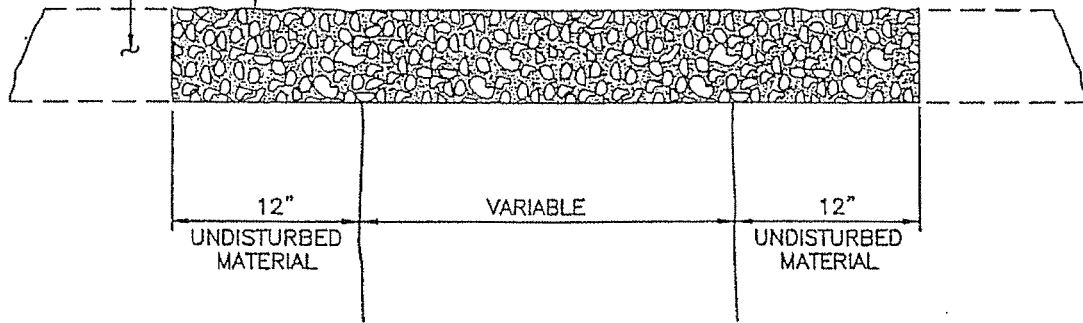
TYPE 'A' No. 57 COARSE AGGREGATE
PENNDOT SECT. 703.2 (NO SLAG)
OR LIMESTONE CHIPS TO MATCH EXIST.,
CHOKE AND ROLL, 4" MIN. DEPTH.



SLAG DRIVEWAY
RESTORATION DETAIL

(APPLICABLE ONLY TO ROADS RESURFACED IN THE LAST FIVE (5) YEARS.)

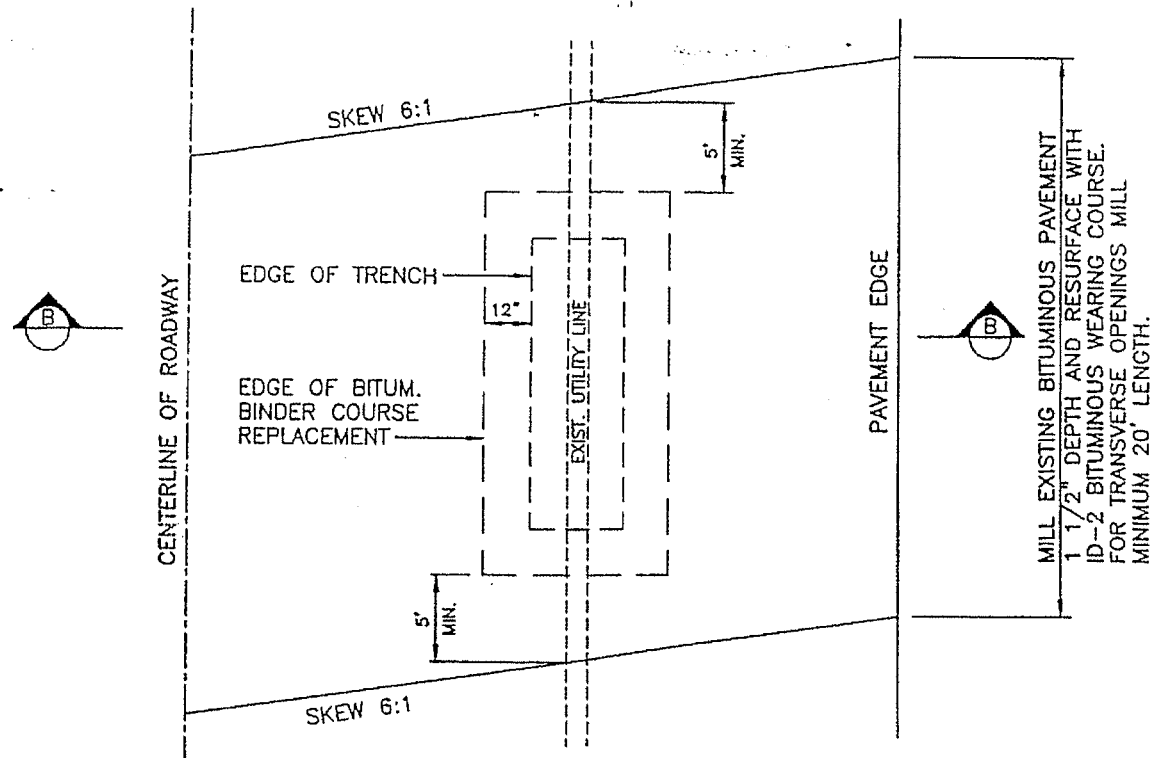

MILL EXISTING BITUMINOUS PAVEMENT
 1 1/2" DEPTH AND RESURFACE WITH
 ID-2 BITUMINOUS WEARING COURSE.
 FOR TRANSVERSE OPENINGS MILL
 MINIMUM 20' LENGTH.

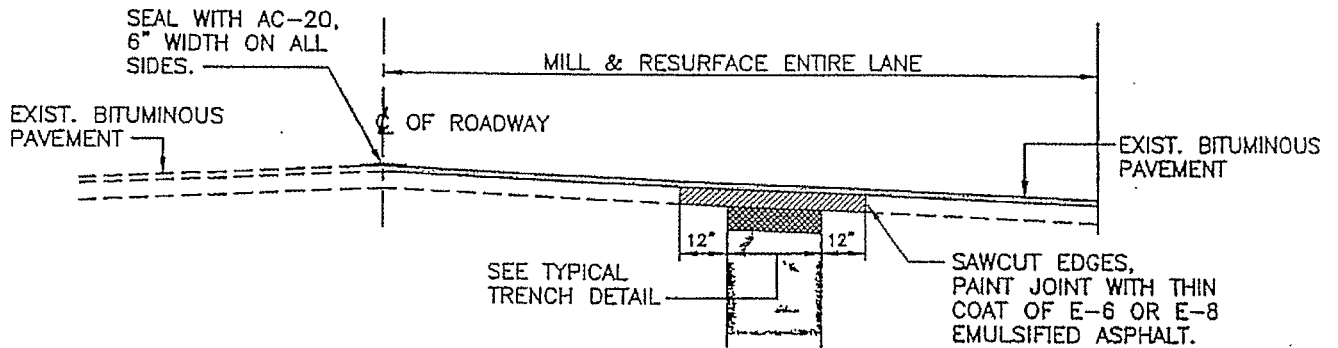

PLAN - PAVEMENT RESTORATION DETAIL 'B'



SECTION B-B

NOTE:

1. 2" MINIMUM BITUMINOUS COLD PATCH (TEMPORARY SURFACE) REQUIRED IN TRENCH AREA PRIOR TO FINAL SURFACING.
2. IF UTILITY OPENING EXTENDS INTO OR INVOLVES BOTH LANES THE ENTIRE CARTWAY SHALL BE MILLED AND RESURFACED.
3. THE MINIMUM LENGTH OF THE MILLED AND RESURFACED AREA SHALL BE 20 FEET.

-  1 1/2" ID-2 BITUMINOUS WEARING COURSE, PENNDOT SECT. 420
-  5" BITUMINOUS CONCRETE BASE COURSE, PENNDOT SECT. 305
-  6" No. 2A SUBBASE, PENNDOT SECT. 350

**STANDARD BITUMINOUS
 PAVEMENT REPLACEMENT DETAIL**

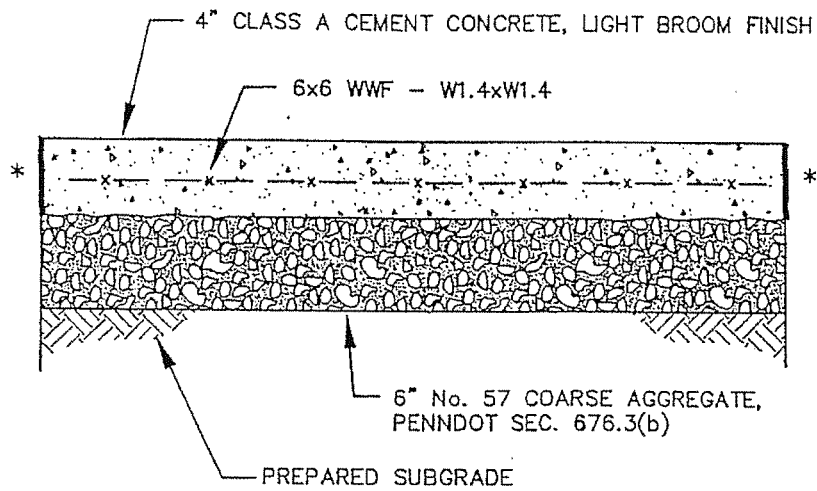

NOTES:

1. FORM OUTSIDE EDGES AND JOINTS WITH 1/4" RADIUS EDGING TOOL.
2. FORM TRANSVERSE DUMMY JOINTS @ 5 FOOT INTERVALS, APPROX. 1/8" WIDE AND AT LEAST 1 INCH DEEP.
- *3. WHEN BUTTING INTO EXISTING BITUMINOUS, SAWCUT BITUMINOUS AND PAINT BITUMINOUS WITH A THIN COAT OF E-6 OR E-8 EMULSIFIED ASPHALT.
- *4. WHEN BUTTING INTO EXISTING CONCRETE, SAWCUT CONCRETE AND USE 1/2" PREMOLDED EXPANSION FILLER FULL DEPTH OF SIDEWALK.

TYPICAL CONCRETE SIDEWALK
REPLACEMENT DETAIL

(APPLICABLE ONLY TO ROADS NOT RESURFACED
IN THE LAST FIVE (5) YEARS.)

SEAL WITH AC-20,
6" WIDTH ON ALL
SIDES.

SEAL JOINTS IN ACCORDANCE WITH PENNDOT
SECT. 401.3(j)3, 6" BOTH SIDES OF JOINT
WITH E-6 OR E-8 EMULSIFIED ASPHALT OR
HOT BITUMINOUS MATERIAL

EXIST. BITUMINOUS
SURFACE

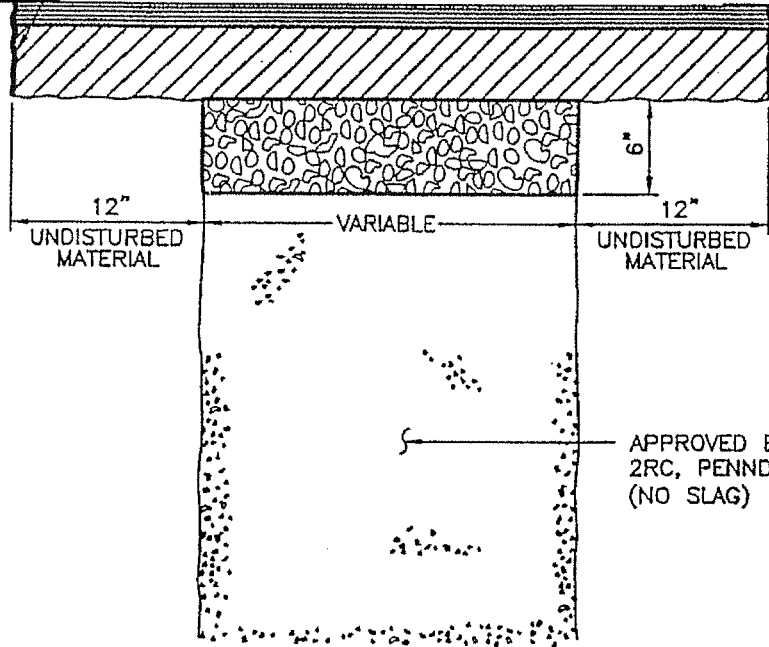



SAWCUT EDGES,
PAINT JOINT WITH THIN
COAT OF E-6 OR E-8
EMULSIFIED ASPHALT.

NOTE:

1. ALL BACKFILL SHALL BE COMPACTED IN 6" LAYERS,
MECHANICALLY TAMPED.
2. TEMPORARY BITUMINOUS COLD PATCH SHALL BE USED IN ALL
AREAS WHERE EXISTING FLEXIBLE-BASE PAVEMENT HAS BEEN
REMOVED.

 1 1/2" ID-2 BITUMINOUS WEARING COURSE,
PENNDOT SECT. 420

 5" BITUMINOUS CONCRETE BASE COURSE,
PENNDOT SECT. 305

 6" No. 2A SUBBASE,
PENNDOT SECT. 350

STANDARD TRENCH DETAIL
AND PAVEMENT REPLACEMENT FOR
BITUMINOUS PARKING AREAS, DRIVEWAYS,
BERMS, AND TOWNSHIP ROADS